

歩車道境界ブロック (JIS A 5371)

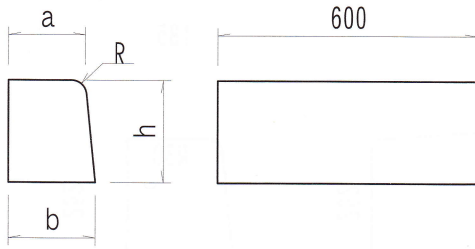

単位 mm

呼び名		寸 法				参考重量 (kg)
		a	b	h	R	
歩車道境界ブロック (片面取り)	A	150	170	200	20	44
	B	180	205	250	30	66
	C	180	210	300	30	81

地先境界ブロック (JIS A 5371)

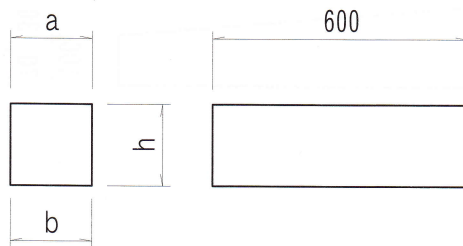

単位 mm

呼び名		寸 法			参考重量 (kg)
		a	b	h	
地先境界ブロック	A	120	120	120	19
	B	150	150	120	24
	C	150	150	150	30

単位 mm

呼び名		寸 法			参考重量 (kg)
		a	b	h	
都市基盤整備公団型		100	100	100	14

切下げブロック上 参考重量/75kg

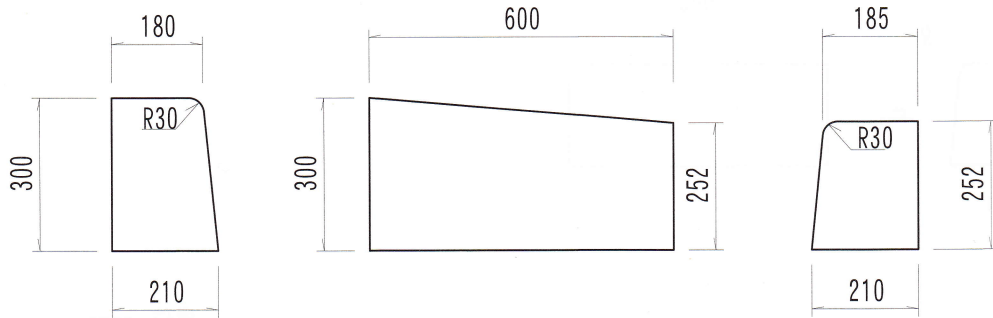

切下げブロック中 参考重量/88kg

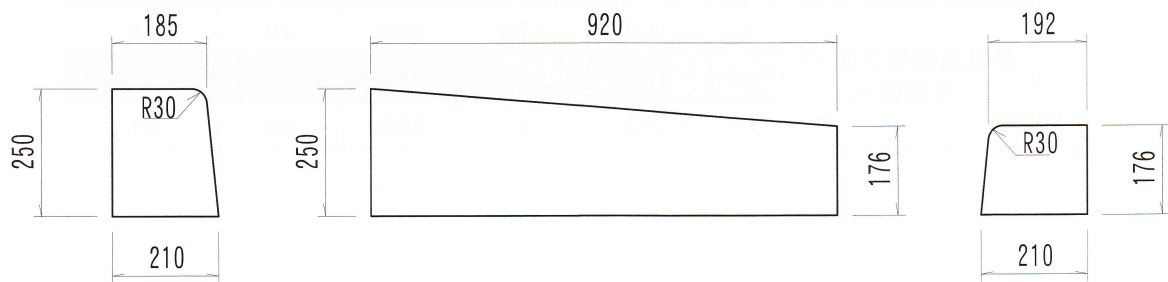

切下げブロック下 参考重量/56kg

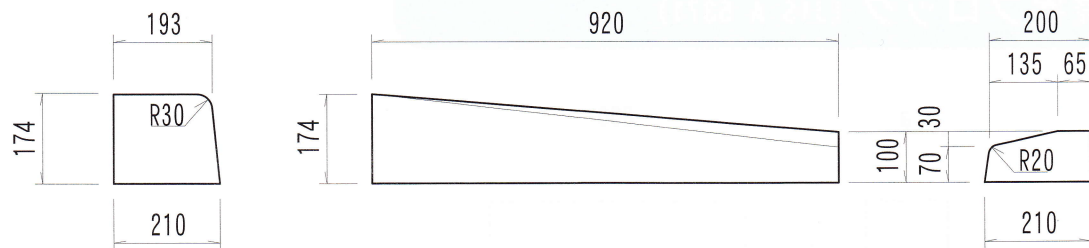

Dブロック 参考重量/26kg

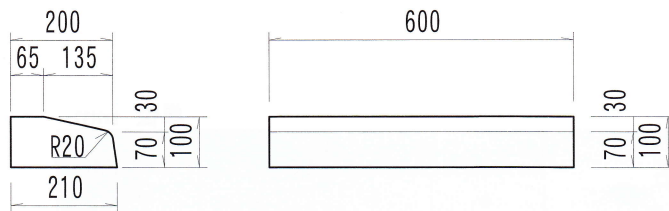

切下げ部施工図

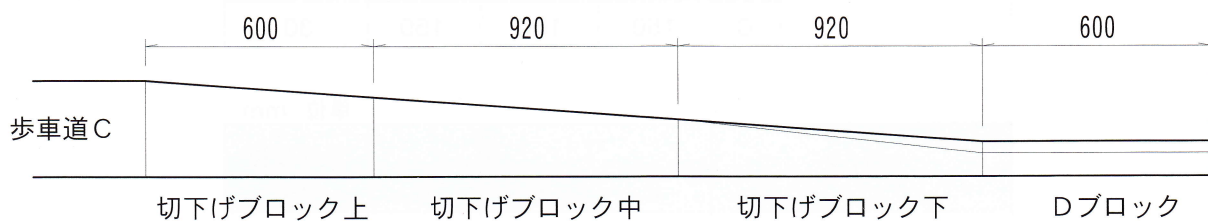

標準 参考重量/80kg

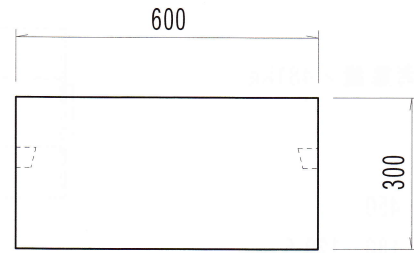
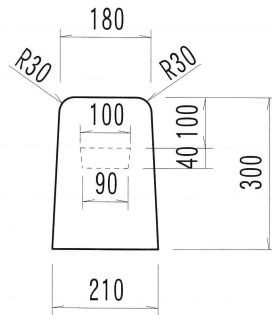

水抜 参考重量/60kg

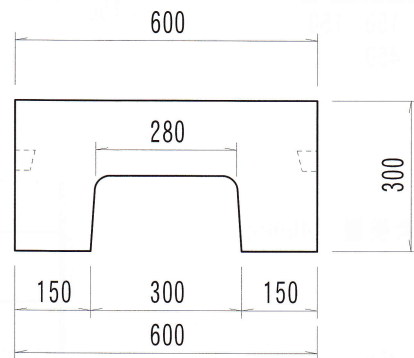
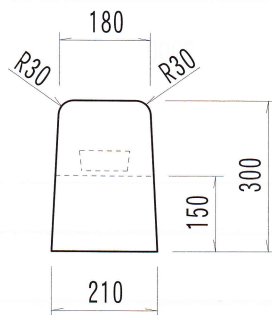

斜 参考重量/56kg

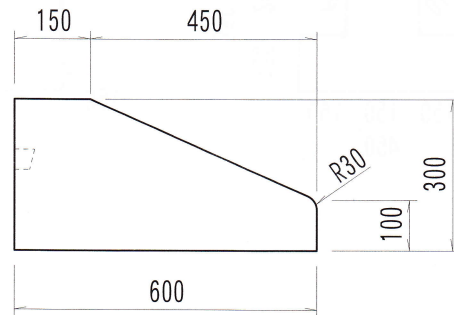
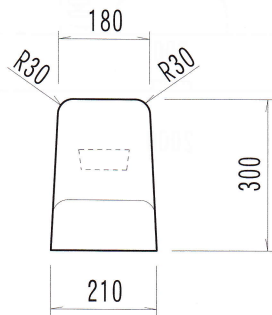

基礎ブロック L=600 参考重量/72kg
L=900 108kg

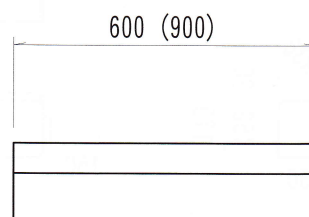
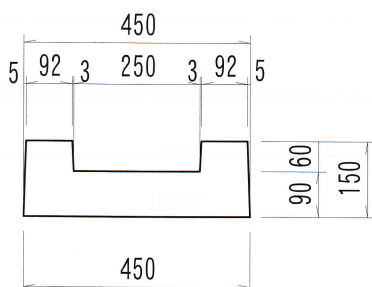

基礎付歩車道境界ブロックLB型 (茨城県規格)

単位 mm

道路用製品

標準 参考重量/481kg

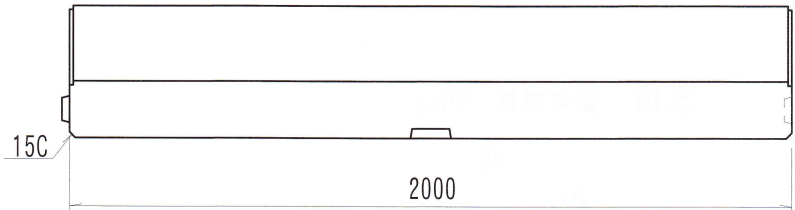
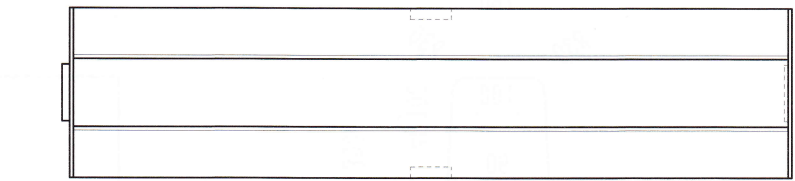
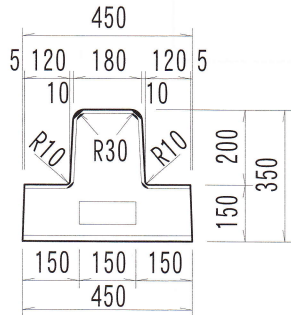

水抜 参考重量/469kg

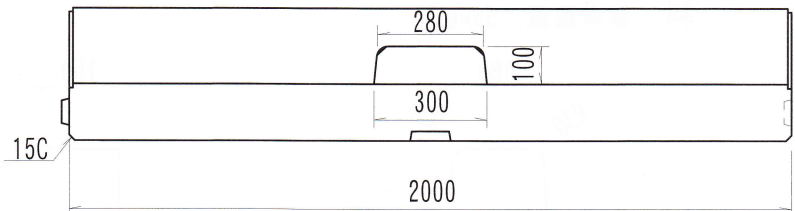
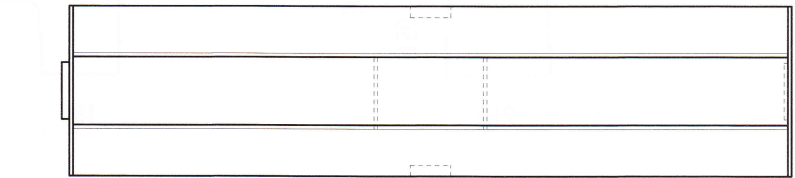
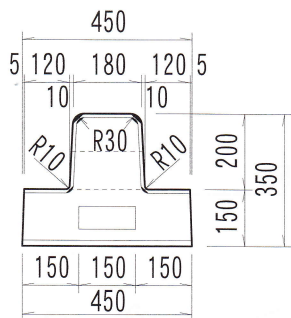

平 20 参考重量/321kg

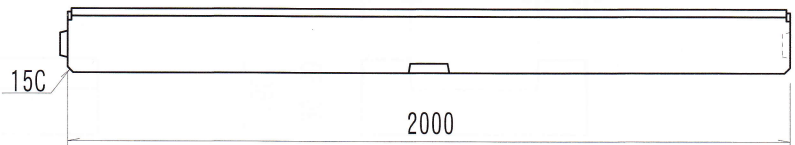
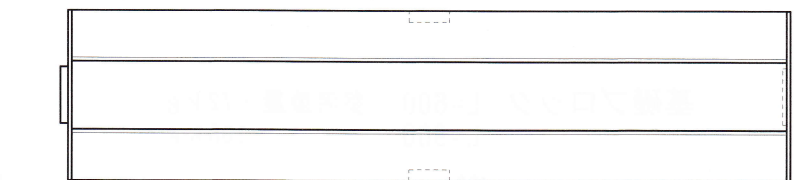
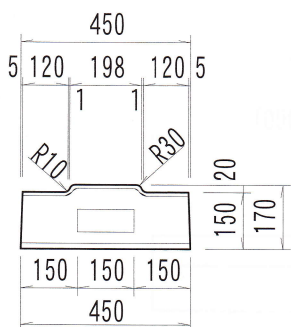

斜 参考重量 / 467kg

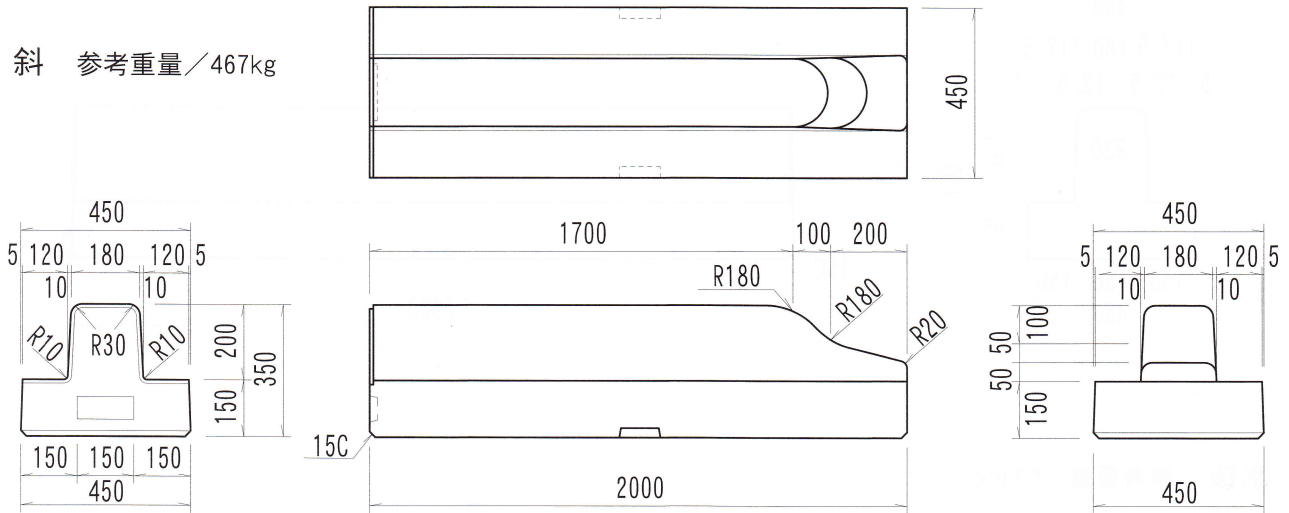

反射板仕様
参考重量 / 467kg

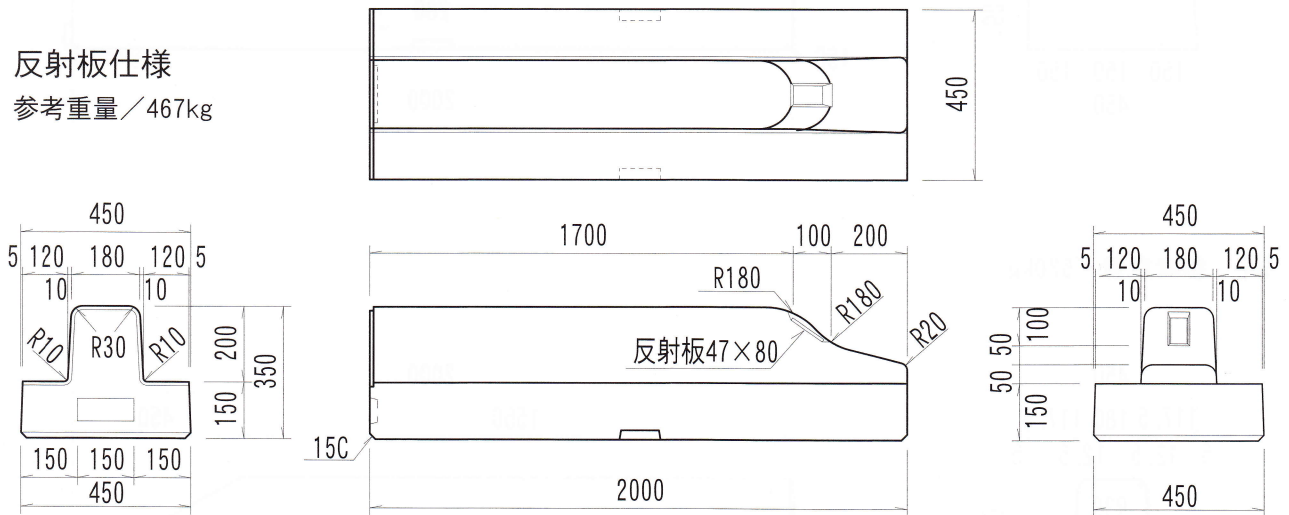

基礎付歩車道境界ブロックLE型 (茨城県規格)

単位 mm

道路用製品

標準 参考重量 / 550kg

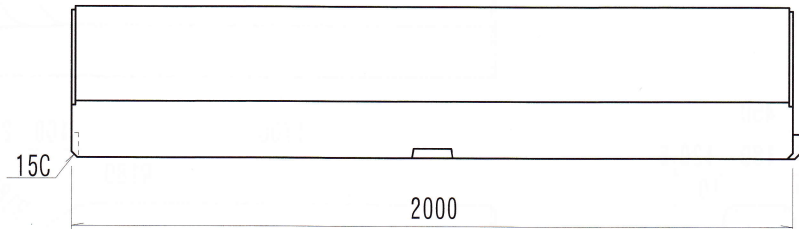
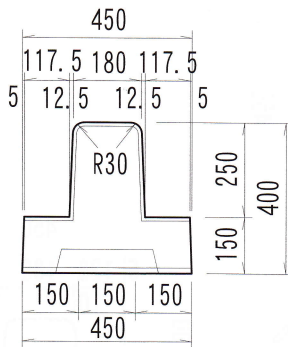

水抜 参考重量 / 530kg

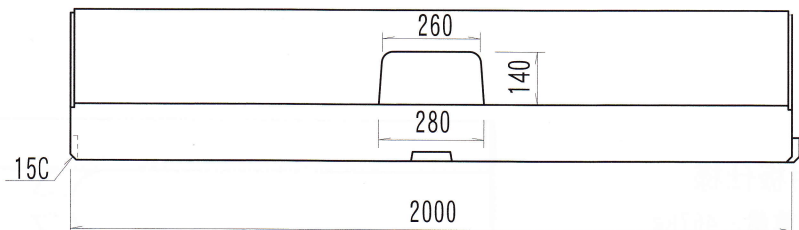
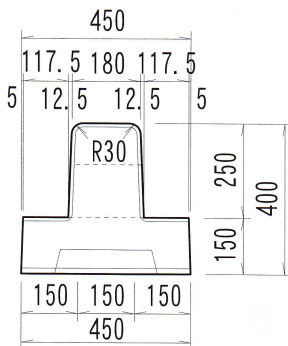

斜 参考重量 / 520kg

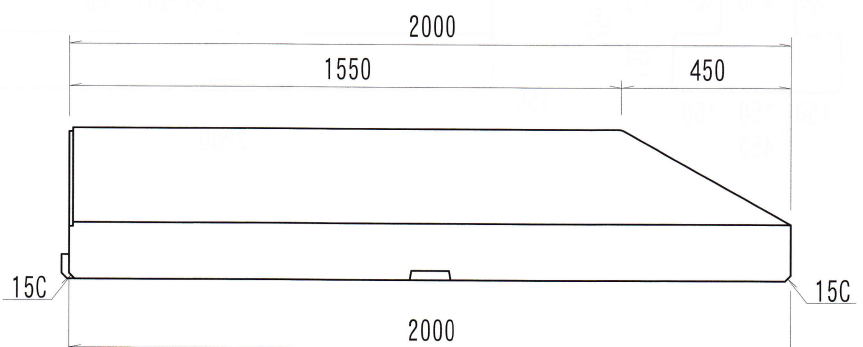
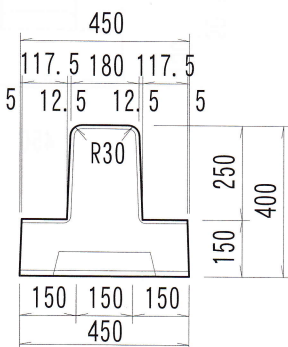

1号ブロック

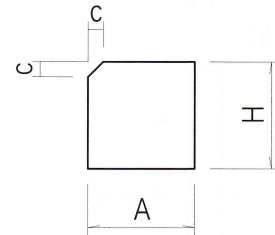
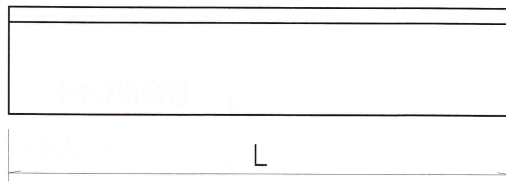

2号ブロック

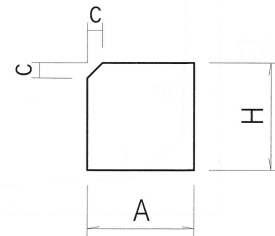
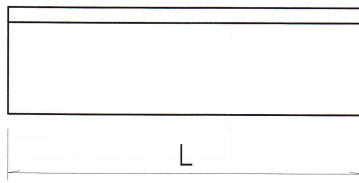

3号ブロック

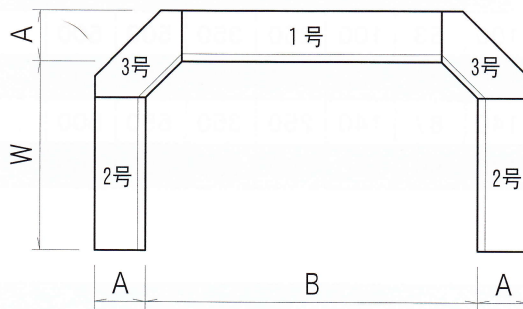
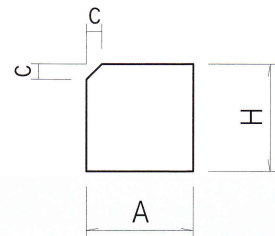
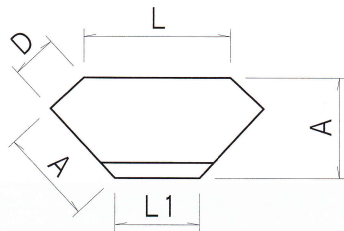

単位 mm

呼び名		寸 法							参考重量 (kg)	
		A	H	c	L	L1	D	W		B
120×150	1号	120	150	11	800	-	-	690	960	33
	2号	120	150	11	600	-	-			24
	3号	120	150	11	212	113	50			9
150×180	1号	150	180	15	900	-	-	760	1200	54
	2号	150	180	15	600	-	-			36
	3号	150	180	15	336	212	62			20